

Champion®



INFRARED DIESEL HEATER

MODEL NO: DEVIL IRD40B

PART NO: 6920417

OPERATION & MAINTENANCE INSTRUCTIONS

UK
CA | CE



ORIGINAL INSTRUCTIONS

DL0624 - ISS.6

INTRODUCTION

Thank you for choosing this Clarke Infrared Heater. Before attempting to use this product, please read this manual thoroughly and follow the instructions carefully. In doing so you will ensure the safety of yourself and that of others around you, and you can look forward to your heater giving you long and satisfactory service.

Please keep these instructions in a safe place for future reference.

FUNCTION AND OPERATING PARAMETERS

This is a multi-fuel (Diesel or Paraffin), forced air heater. It's intended use is for drying and the warming of commercial/industrial buildings where adequate ventilation is provided.

- It must be operated as prescribed in the operating manual.
 - It is not intended to be used for domestic use or for the heating of habitable areas.
 - It is not intended to be used to reach and maintain a certain level of human thermal comfort within an enclosed space in which the heater is situated.
 - It is not intended to be used in enclosed areas with restricted ventilation.
 - It is not for use in areas with high levels of fluctuating drafts.
 - It is not intended for warming animals or live stock.
-

GUARANTEE

This product is guaranteed against faulty manufacture for a period of 12 months from the date of purchase. Please keep your receipt which will be required as proof of purchase.

This guarantee is invalid if the product is found to have been abused or tampered with in any way, or not used for the purpose for which it was intended.

Faulty goods should be returned to their place of purchase, no product can be returned to us without prior permission.

This guarantee does not effect your statutory rights.

ENVIRONMENTAL RECYCLING POLICY



Through purchase of this product, the customer is taking on the obligation to deal with the WEEE in accordance with the WEEE regulations in relation to the treatment, recycling & recovery and environmentally sound disposal of the WEEE.

In effect, this means that this product must not be disposed of with general household waste. It must be disposed of according to the laws governing Waste Electrical and Electronic Equipment (WEEE) at a recognised disposal facility.

If disposing of this product or any damaged components, do not dispose of with general waste. This product contains valuable raw materials. Metal products should be taken to your local civic amenity site for recycling of metal products.

TECHNICAL SPECIFICATION

Dimensions (L x W x H)	635 x 925 x 860 mm
Weight (empty)	28.4 kg
Fuel	Diesel/Paraffin
Fuel consumption	3.8l/h - 3.2 kg/h
Fuel Tank capacity	38 litres
Ignition type	Direct spark ignition
Continuous working time	10 hr (before re-fueling)
Over heating protection	120°C
Max output	40 kW (136,484 Btu/h)
Operating Temperature	-20 - 45°C
Duty cycle	S1 (continuous)
Fuel pump pressure	Factory set at 6.5 bar
Electrical supply	230V 50 Hz
Ingress Protection degree	IPX4
Sound Power level	67 dB LpA

GENERAL SAFETY PRECAUTIONS



CAUTION: FAILURE TO FOLLOW THESE PRECAUTIONS COULD RESULT IN PERSONAL INJURY, AND/OR DAMAGE TO PROPERTY.

CAUTION: DUE TO THE HIGH SURFACE AND EXHAUST TEMPERATURES, ADULTS, CHILDREN AND ANIMALS MUST KEEP CLEAR OF THE UNIT TO AVOID BURNS OR CLOTHING IGNITION.

GENERAL

1. **ALWAYS** read and ensure you fully understand the following precautions and the hazards associated with this heater. **DO NOT** allow anyone who has not read these instructions to operate it.
2. **NEVER** carry out any modifications to this heater. If experiencing difficulty of any kind consult your local Clarke dealer.
3. Only use the heater in accordance with any applicable fire, local building and/or site regulations.

OPERATING ENVIRONMENT

1. This heater is intended for drying & warming of commercial/industrial buildings where adequate ventilation is provided. It is **NOT** for domestic use or for heating habitable areas.
2. The heater should **NOT** be used by children or persons with reduced physical, sensory or mental capabilities, or lack of experience and knowledge.
3. **DO NOT** expose the heater or power cable to rain or wet conditions. Any water entering the heater will increase the risk of electric shock.
4. **NEVER** use the heater where petrol, paint thinners or other highly flammable vapour may be present.
5. The heater should **ALWAYS** be positioned well away from sources of air-borne dust, as ingress of dust into the heater may cause it to malfunction. It will be beneficial to shield the heater from a dusty work environment.
6. **NEVER** locate the heater facing curtains or other combustible materials. **ALWAYS** keep combustibles at least 2.5 m from the front of the heater.
7. Never place anything on top of the heater.
8. **ALWAYS** locate the heater on a level, flat, fireproof surface. Ensure that the heater is correctly and safely positioned as described on page 10.
9. **DO NOT** use this heater in the immediate surrounds of a bath, a shower or a swimming pool.

10. **DO NOT** use this heater in small rooms when they are occupied by persons not capable of leaving the room on their own unless constant supervision is provided.
11. Disconnect the heater from the power supply when not in use.
12. **DO NOT** locate the heater close to an adjacent wall or ceiling. Avoid placing the heater directly below power socket outlets.

PERSONAL SAFETY

1. When the heater is used in the presence of other people the user is responsible for informing those present of the safety precautions and of the hazards involved.
2. The heater is not to be used by children or people with reduced physical, sensory or mental capabilities, or lack of knowledge.
3. **ALWAYS** ensure that people and animals are at least 2.5 m away from the front of the heater when in operation.
4. **NEVER** leave a heater unsupervised while in use - someone should always be made responsible for monitoring it.
5. **DO NOT** move or service the heater while hot or in use.
6. This heater will be hot when in use and should not be touched until it has fully cooled down after shutting down.

REFUELLING

1. **ALWAYS** refuel in a well ventilated area.
2. **ALWAYS** allow the heater to cool down before re-fuelling and refuel away from any source of heat.
3. **NEVER** overfill the tank, only fill to the level specified.
4. Use only clean diesel or paraffin. **NEVER** use gasoline, paint thinners, alcohol or other highly flammable fuels.
5. Take care not to spill diesel or paraffin onto the power cable as this could damage the insulation.
6. **NEVER** move, replenish the fuel supply or handle the heater when it is hot, or in use. Turn it off and wait for it to cool down first.

ELECTRICAL SAFETY

1. Electrical appliances must match the power outlet. Never modify the plug in any way. **DO NOT** use adaptor plugs with earthed (grounded) appliances. Correct plugs and outlets will reduce the risk of electric shock.
2. **DO NOT** abuse the electrical cable by using it to pull or unplug the heater. Keep the cable away from sources of heat, oil, sharp edges or moving

parts. **DO NOT** use if it is damaged, damaged or tangled cables increase the risk of electric shock.

3. Keep the mains cable well away from machines and ensure an adequate electrical supply is close at hand so that the operation is not restricted by the length of the cable.
4. **ALWAYS** disconnect from the mains supply before moving the heater or performing any maintenance tasks.
5. **DO NOT** use this heater with a programmer, timer, separate remote control system or any device that switches the heater on automatically, since a fire risk exists if the heater is covered or positioned incorrectly.

SAFETY SYSTEMS

The unit is fitted with a temperature limit sensor, which is designed to turn the heater off if the temperature should rise to an unsafe level. If the sensor is tripped and the heater is turned off it may require a service. Once the temperature falls back below the reset temperature, the heater should re-start.

The heater is fitted with an electrical circuit breaker to protect the internal components from damage. If the heater should fail to work, this fuse may require checking by your dealer.



The heater is fitted with a tilt switch designed to turn the unit off immediately if it should tip over beyond a pre-determined angle.

SERVICE & REPAIRS

1. Check the heater for damage before use. **DO NOT** use if the heater is damaged or dropped. Any damage should be properly repaired or the part replaced. If in doubt, **DO NOT** use the heater. Consult your local dealer.
2. When necessary, have your heater serviced or repaired by a qualified person using identical replacement parts. This will ensure that the safety of the heater is maintained.

SAFETY SYMBOLS

The following symbols appear on the heater.

	Hot Surface, DO NOT TOUCH		DO NOT COVER
---	----------------------------------	---	---------------------

ELECTRICAL CONNECTIONS



WARNING: READ THESE ELECTRICAL SAFETY INSTRUCTIONS THOROUGHLY BEFORE CONNECTING THE PRODUCT TO THE MAINS SUPPLY.

Connect the mains lead to a standard 230Volt 50Hz electrical supply through an approved 13 amp BS1363 plug or a suitably fused isolator switch.

If the plug has to be changed because it is not suitable for your socket, or due to damage, it should be cut off and a replacement fitted, following the wiring instructions shown below. The old plug must be disposed of safely, as insertion into a mains socket could cause an electrical hazard.



**WARNING: THE WIRES IN THE POWER CABLE OF THIS PRODUCT ARE COLOURED IN ACCORDANCE WITH THE FOLLOWING CODE:
BLUE = NEUTRAL BROWN = LIVE YELLOW AND GREEN = EARTH**

If the colours of the wires in the power cable of this product do not correspond with the markings on the terminals of your plug, proceed as follows.

- The BLUE wire must be connected to the terminal which is marked **N** or coloured **Black**.
- The BROWN wire must be connected to the terminal which is marked **L** or coloured **Red**.
- The YELLOW & GREEN wire must be connected to the terminal which is marked **E** or  or coloured **Green**.

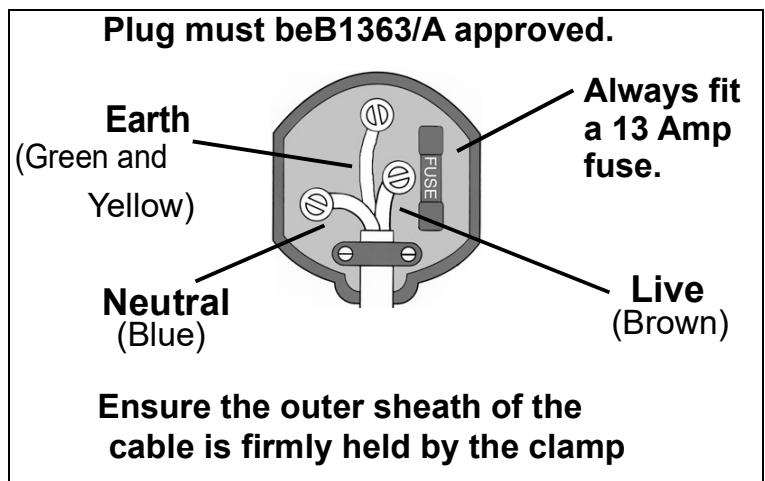

We strongly recommend that this machine is connected to the mains supply via a Residual Current Device (RCD).

If in any doubt, consult a qualified electrician. DO NOT attempt any repairs yourself.

DEVIL IRD40B HEATER OVERVIEW

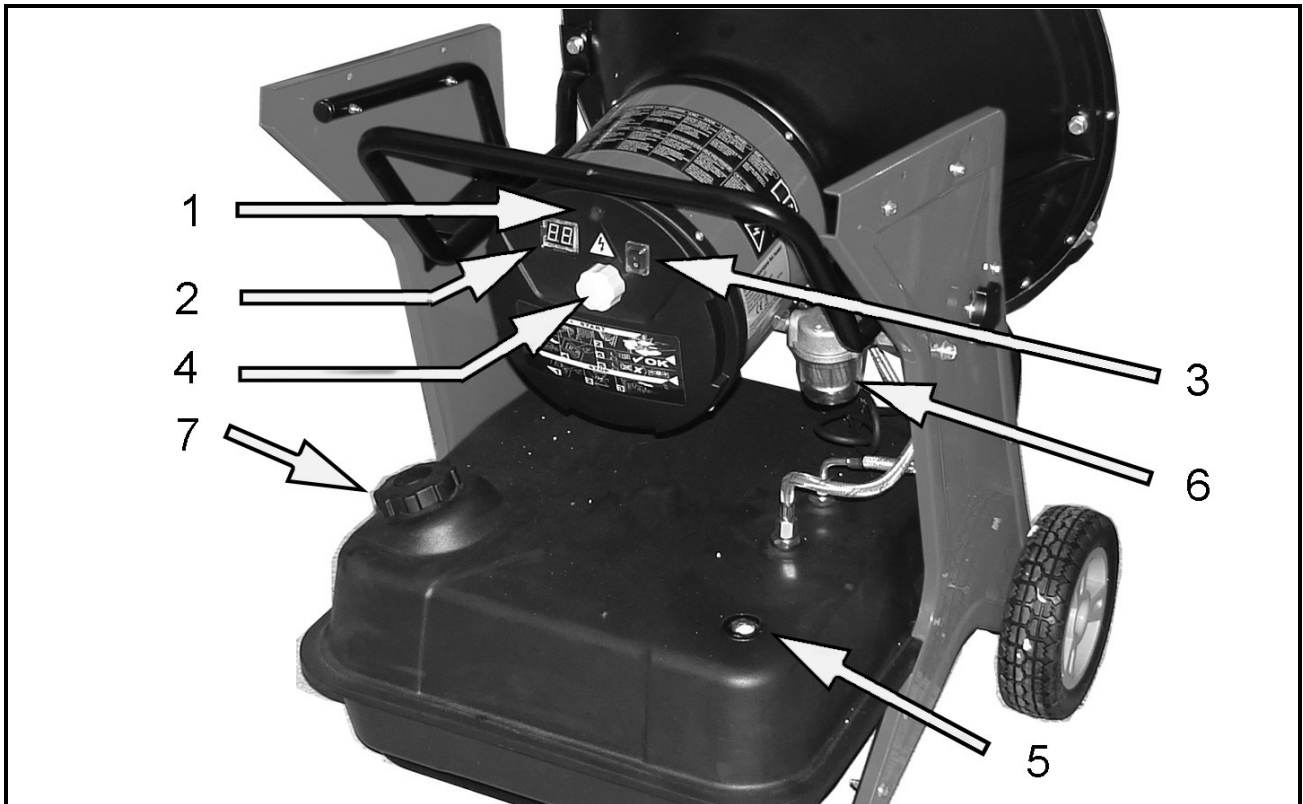

1	Power-on LED	5	Fuel gauge
2	Digital temperature display	6	Fuel Filter
3	Power switch	7	Fuel filler cap
4	Temperature control knob		

FUNCTIONAL DESCRIPTION

A pump draws fuel from the tank and drives it to the burner under pressure. Fuel is sprayed and atomised by the nozzle and then ignited by the burner ignition device. A built-in radial blower provides combustion airflow while air and fuel forms a combustion mixture. The flames heat up the front plate and guard, thus releasing heat by radiation.

The burner pre-heater warms up the fuel before start-up and the post-ventilation function cools down the chamber after each use. No flue or exhaust pipe is required as all combustion gasses are catalysed during operation.

The unit can be tilted from 12 to 27° to direct heat at a particular target.

PREPARATION

UNPACKING & ASSEMBLY

When unpacking, check the heater for any damage that may have occurred in transit and notify your Clarke dealer immediately should any be apparent.

1. Fit the heat shield to the heater body using three screws/nuts near the top of the heater.

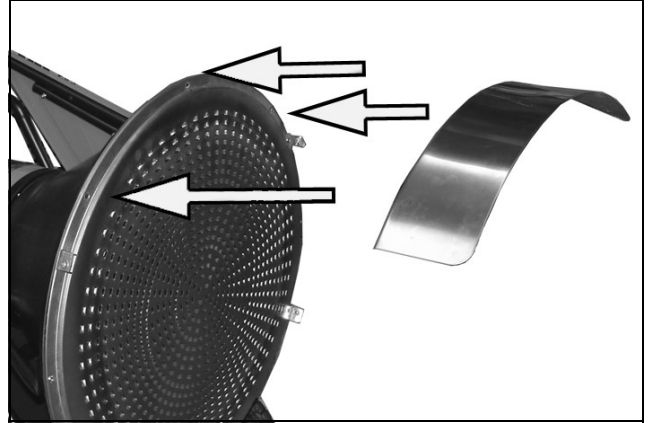

2. Fit the front grille to the heater using four screws into the captive nuts secured to the frame.

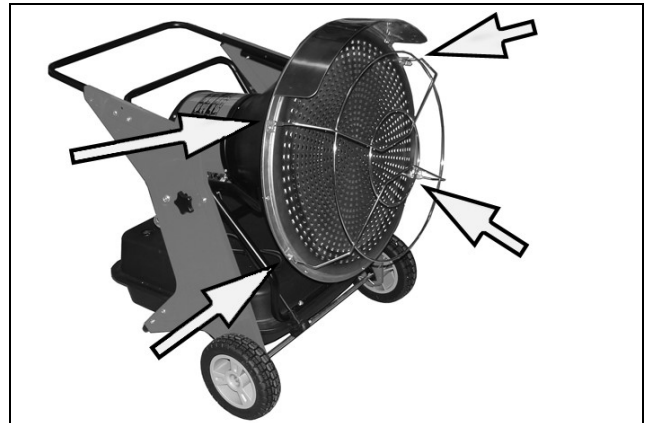

3. Fit the handle to the rear of the heater using four bolts/nuts supplied loose.

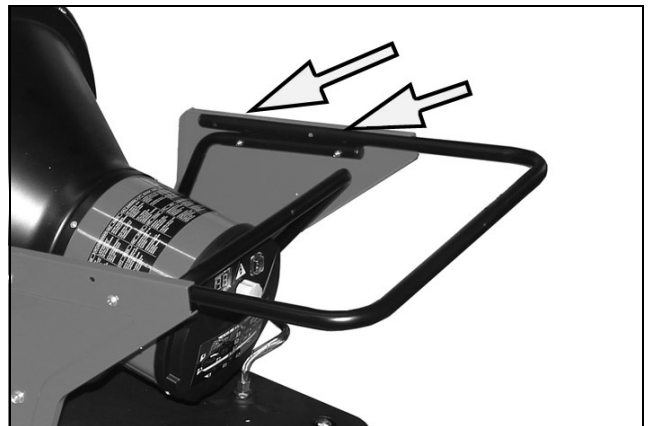

SUITABLE FUELS

Diesel or paraffin (kerosene) are the only fuels that should be used.

FILLING THE FUEL TANK

Before re-fuelling, disconnect from the power supply and allow to cool down.

Fill the tank with clean, water-free diesel oil. When refilling, inspect the mesh filter inside the filler neck for any trapped contamination and clean out if necessary.

- When filling the heater, make sure that the heater is level and do not overfill. Use a funnel or can with a long filling spout.



Plug the heater into any suitably earthed mains power supply.

NOTE: In cold weather, condensation may develop in the tank if the tank is empty. Before filling the fuel tank for the first time or after extended storage periods, vent the fuel tank of any moisture or condensation.

POSITIONING THE HEATER

The heater must be located on a hard, level surface to minimise the risk of accidental tipping over or running forward. Chock the wheels if there is any possibility of movement.

Set the heater angle of inclination by loosening and re-tightening the positioning knobs on either side to achieve the required angle of tilt.

This heater should not be used in habitable areas.

The heater should always be positioned well away from sources of airborne dust, as ingress of dust into the heater may cause it to malfunction. It will be beneficial to shield the heater from a dusty work environment

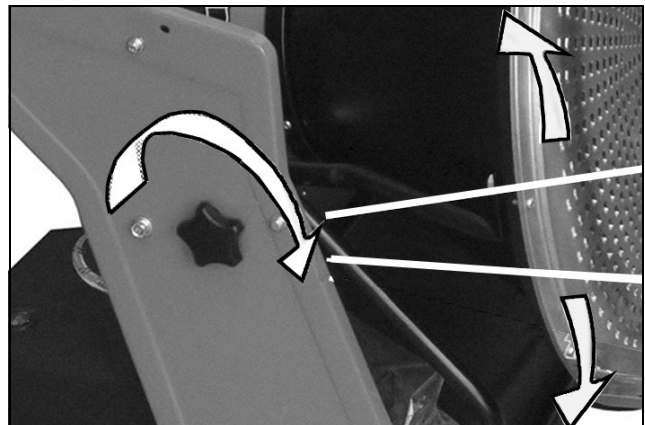

MATERIAL CLEARANCES

It is important that the heater be positioned with at least 3 m clearance at the front between the heater and any obstruction including walls or other combustible surfaces. Always position the heater facing the centre of the room. Never place any objects on, or against the heater.

Any equipment or workshop furniture should be a safe distance away as they could be adversely affected by heat. When the heater is in use, periodically monitor any buildup of heat on nearby surfaces.

VENTILATION

Even though this heater operates very close to 100 percent combustion efficiency, it still produces small amounts of carbon monoxide.

Carbon monoxide (CO) is toxic and can build up in a confined spaces and failure to provide adequate ventilation can be fatal.

The early symptoms of asphyxiation caused by inadequate ventilation are:

- headache
 - dizziness
 - nausea
 - dry mouth or sore throat
1. Only use in well ventilated areas and make sure that ample ventilation is present if the heater is being started following a long period without use.
 2. **NEVER** attach any duct work to the front of the heater.
 3. **NEVER** cover or impede airflow into or out of the heater.

WE RECOMMEND THE USE OF A CARBON MONOXIDE DETECTOR

HEATER OPERATION WITHOUT PEOPLE IN THE ROOM

Ensure that sufficient air is available via windows and doors for complete combustion. The heated volume (m₃) / heat output (kW) ratio must be at least 10:1, and personnel should not stay permanently in the heated room.

HEATER OPERATION WITH PEOPLE REMAINING IN THE ROOM

If people are to remain in the room for any length of time, the heated volume (m₃) /heat output (kW) must be at least 30:1. Air circulation must be ensured through windows and doors or permanent openings near the floor and ceilings, whose total open area (m₂) is at least 0.003 times the total heat output (kW).

OPERATION

HEATER START UP

1. Plug the heater into the mains power supply.
2. Set the power switch to the ON position.
 - The 'power-on' LED will illuminate and the digital temperature display will show the room temperature for up to 3 minutes.
 - Turn the temperature control knob to adjust the target temperature required. This setting will be shown by the digital display.

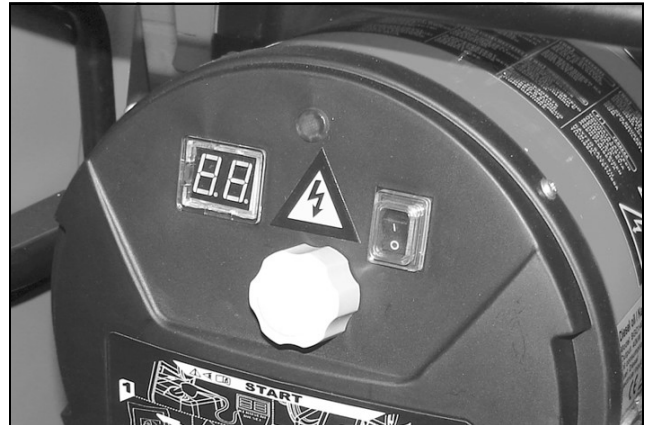

NOTE: If the heater does not start up, the temperature control may be set too low. Turn the control knob to a higher setting until the heater starts. If the heater does not start, switch the power switch off, then switch back on again. If the heater still does not start, refer to fault-finding guide on page 13. Also check that the power supply is correct.

HEATER SHUT DOWN & RE-STARTING

1. Set the power switch to the OFF position but do not unplug from the mains.

NOTE: When the heater is shut down, the fan will continue running for 3 minutes to expel hot air and cool the casing. For this reason the heater should not be unplugged.
2. Only for extended shutdown should the heater be unplugged from the mains supply.
3. If re-starting, wait 10 seconds after shutting off the heater before re-starting.
 - Set the power switch to the ON position and follow the startup procedure above.
4. Store the heater in a level position when filled, or fuel leakage may occur.

FAULT CODE DISPLAY

The digital display can show the following fault codes.

FAULT CODE	CAUSE	SOLUTION
FO:- Operation Error	1. Heater is switched on before being plugged in.	1. Disconnect from power supply, switch off and then plug in again before switching on.
F1:- Photocell Error	1. No fuel 2. Fuel is contaminated 3. Photocell is dirty or damaged. 4. Fuel filter is dirty. 5. Ignition error	1. Switch off and refill the tank. 2. Switch off, empty and refill the fuel tank. Clean the filter with clean fuel. 3. Contact your dealer. 4. Clean filter. 5. Contact your dealer.
F2:- Temperature Control Sensor error	1. Damaged cable 2. Sensor is damaged.	1. Contact your dealer. 2. Contact your dealer.
F3:- Thermostat Error	1. Internal parts over heating. 2. Anti-tilting sensor activated.	1. Turn the heater off and wait until it has cooled down. 2. Reposition heater on a level surface.
LO	1. External temperature below -9°C	1. Wait for normal temperature conditions
CH	1. Air temperature over 55°C.	1. Wait for normal temperature conditions

CLEANING AND MAINTENANCE



WARNING: ALWAYS ENSURE THE HEATER HAS COOLED DOWN BEFORE PERFORMING ANY MAINTENANCE TASKS

Before carrying out any adjustment or maintenance, ensure the heater is switched OFF, disconnected from the mains supply, and has been given adequate time to cool down.

CLEANING

1. Use a damp cloth wrung out in a solution of soapy water to clean the exterior of the heater. Use household cleaners on difficult spots.
2. Never use abrasive cleaners as they may damage the paint finish.
3. The internal heating surfaces and combustion chamber of the burner should be cleaned at least annually.

GENERAL MAINTENANCE

Correct maintenance is vital for smooth operation of the burner in order to avoid wasting fuel and causing atmospheric pollution.

1. This heater should be inspected, cleaned and serviced annually by a qualified service engineer. Unauthorised persons should not attempt to carry out repairs of the burner components.
2. Replace the fuel filter cartridge if water or dirt particles can be seen in the glass filter bowl and at approx 200 operating hours or as needed.

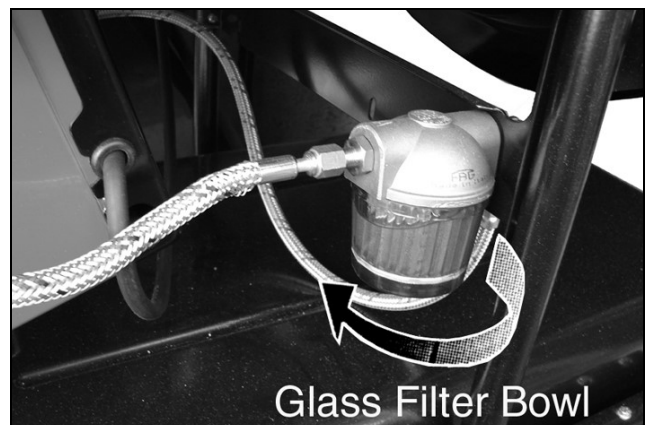

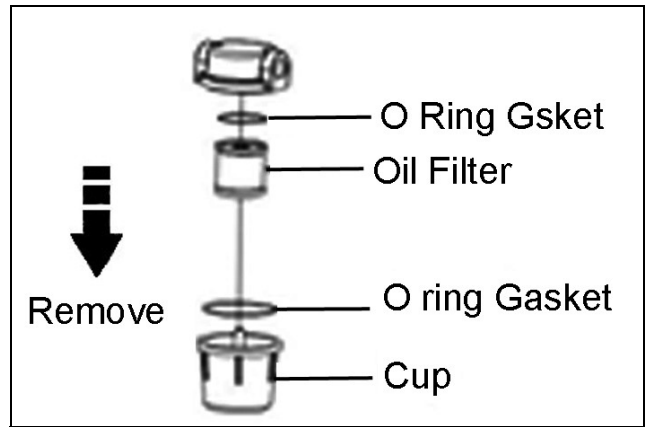

3. Burner nozzles should be cleaned or replaced at least once per heating season. Contaminated fuel cause make this necessary much sooner.
4. To clean dirt from the nozzle blow compressed air through the nozzle front. It may be necessary to soak in clean diesel to help loosen any remaining material.

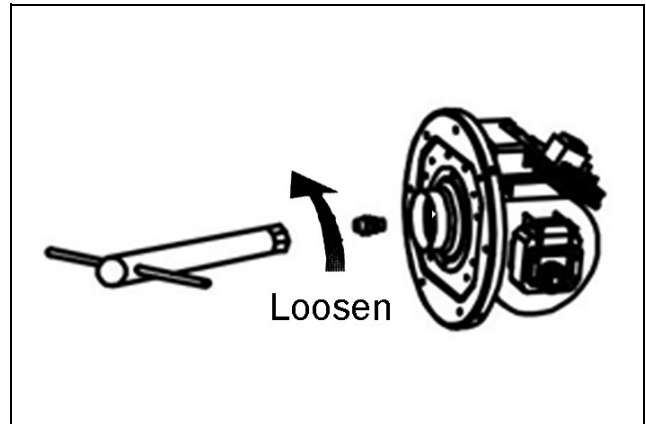

5. Empty the tank and refill with fresh fuel if you suspect the fuel has become contaminated.

In the event of damage or broken components, replacements are available from Clarke Parts & Service.

LONG TERM STORAGE

1. For long term storage, unscrew the drain plug and drain out any remaining fuel. Use a small amount of fresh fuel to rinse and swirl the fuel in the tank and empty completely. Avoid storing leftover diesel in the tank during the summer season as old fuel can be damaging to the heater components.
2. Always store the heater in a dry, well ventilated area away from combustible materials. Cover the heater and keep dry and dust free.

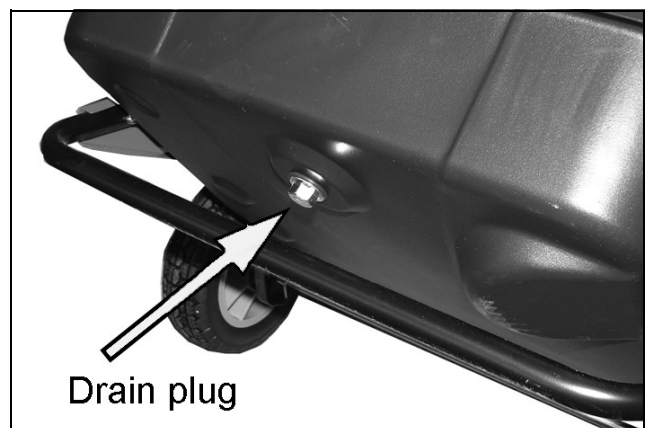

FAULT FINDING

Problem	Cause	Solution
Heater fires but shuts off after a short period of time.	<ol style="list-style-type: none"> 1. Dirty fuel filter 2. Nozzle is dirty 3. Photocell lens is dirty 4. Photocell not installed properly. 5. Photocell defective 6. Bad connection between PCB and photocell 	<ol style="list-style-type: none"> 1. Clean/replace fuel filter 2. Clean/replace nozzle 3. Clean photocell 4. Adjust photocell position 5. Return to dealer for new photocell 6. Ask dealer to check wiring connections
Heater will not operate	<ol style="list-style-type: none"> 1. No fuel in tank 2. Corroded spark plug or incorrect plug gap 3. Dirty fuel filter 4. Dirty nozzle 5. Moisture in fuel/tank 6. Bad electrical connection between transformer and PCB 7. Igniter wire not connected to sparkplug 8. Defective igniter 	<ol style="list-style-type: none"> 1. Fill tank with fresh fuel. 2. Ask dealer to clean/regap/replace spark plug 3. Clean/replace fuel filter 4. Ask dealer to clean/replace nozzle. 5. Rinse out fuel tank with clean, fresh fuel. 6. Return to dealer. 7. Return to dealer for repair. 8. Return to dealer for repair.
Fan does not operate when heater is switched on.	<ol style="list-style-type: none"> 1. Thermostat is set too low 2. Broken electrical connection between main PCB and motor. 	<ol style="list-style-type: none"> 1. Turn the thermostat to a higher setting 2. Ask dealer to check all electrical connections.
Poor combustion and/or excessive soot production.	<ol style="list-style-type: none"> 1. Dirty fuel filter 2. Poor quality fuel. 	<ol style="list-style-type: none"> 1. Clean/replace fuel filter 2. Check that fuel is not contaminated or old.
Heater does not turn on and the lamp does not light.	<ol style="list-style-type: none"> 1. Temperature limit sensor has overheated. 2. No electrical power 3. Fuse blown 4. Bad connection between temperature limit sensor and PCB. 	<ol style="list-style-type: none"> 1. Set the power switch to off and allow the heater to cool for 10mins before switching back on. 2. Check the power cable for good connection. Test the power supply. 3. Return to dealer for repair. 4. Return to dealer for repair.

DECLARATIONS OF CONFORMITY - UKCA



Hemnall Street, Epping, Essex, CM16 4LG

DECLARATION OF CONFORMITY

This is an important document and should be retained.

We hereby declare that this product(s) complies with the following legislation:

The Electromagnetic Compatibility Regulations 2016

The Electrical Equipment (Safety) Regulations 2016

The Restriction of the Use of Certain Hazardous Substances in Electrical and Electronic Equipment Regulations 2012

The following standards have been applied to the product(s):

EN 60335-1:2012+A11:2014+A13:2017+A1:2019+A14:2019+A2:2019+A15:2021, EN 62321-2:2014, EN 61000-3-3:2013+A1:2019+A2:2021, EN IEC 61000-3-2:2019+A1:2021, EN 60335-2-102:2016, EN 62321-4:2014/A1:2017, EN 62321-5:2014, EN 62321-6:2015, EN 62321-8:2017, EN 62233:2008, EN IEC 55014-1:2021, EN IEC 55014-2:2021, EN 62321-7-1:2015, EN 62321-7-2:2017, EN 62321-3-1:2014, EN 13842:2004

The technical documentation required to demonstrate that the product(s) meet(s) the requirement(s) of the aforementioned legislation has been compiled and is available for inspection by the relevant enforcement authorities.

The UKCA mark was first applied in: 2021

Product Description: Space Heater
Model Number(s): DEVIL IRD40B
Serial/Batch Number: Refer to product/package label
Date of Issue: 11/06/2024

Signed:

J.A Clarke

Director

DECLARATIONS OF CONFORMITY - CE



Clarke[®]
INTERNATIONAL

Fitzwilliam Hall, Fitzwilliam Place, Dublin 2

DECLARATION OF CONFORMITY

This is an important document and should be retained.

We hereby declare that this product(s) complies with the following legislation:

2014/30/EU *Electromagnetic Compatibility Directive*
2014/35/EU *Low Voltage Directive*
2011/65/EU *Restriction of Hazardous Substances (RoHS) Directive*

The following standards have been applied to the product(s):

*EN 60335-1:2012+A11:2014+A13:2017+A1:2019+A14:2019+A2:2019+A15:2021, EN 62321-2:2014,
EN 61000-3-3:2013+A1:2019+A2:2021, EN IEC 61000-3-2:2019+A1:2021, EN 60335-2-102:2016,
EN 62321-4:2014/A1:2017, EN 62321-5:2014, EN 62321-6:2015, EN 62321-8:2017, EN 62233:2008,
EN IEC 55014-1:2021, EN IEC 55014-2:2021, EN 62321-7-1:2015, EN 62321-7-2:2017,
EN 62321-3-1:2014, EN 13842:2004*

The technical documentation required to demonstrate that the product(s) meet(s) the requirement(s) of the aforementioned legislation has been compiled and is available for inspection by the relevant enforcement authorities.

The CE mark was first applied in: 2017

Product Description: Space Heater
Model Number(s): DEVIL IRD40B
Serial/Batch Number: Refer to product/packaging label
Date of Issue: 11/06/2024

Signed:

J.A Clarke

Director

ADDITIONAL CLARKE PRODUCTS

CAM250 10" VENTILATOR



250w, 230v/1 phase motor
Flow rate@full speed 1284cfm

Part No. 3220450

JERRY CANS & SPOUTS



5, 10 & 20 LITRE SIZES

Part Nos. 765000-995

Spouts (fixed/flexible)

MGH1 Mobile Gas Heater



Compact, mobile heater for
instant warmth in the home,
office, workshop etc
REquires 15kg butane cylinder
(not included)

Part No. 6920021

18" Box Fan

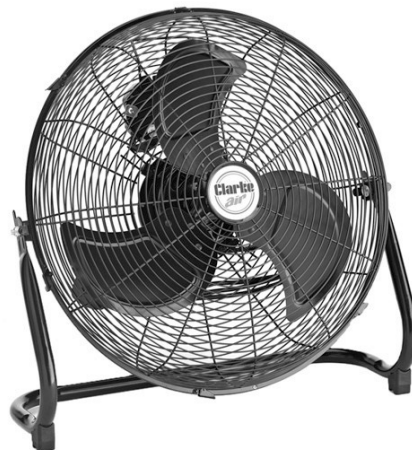

Ideal for creating a high
velocity air flow in domestic
& commercial locations
3-speed airflow control
vertical tilting
Tough moulded construction

Part No. 3230465

A SELECTION FROM THE VAST RANGE OF

Clarke®

QUALITY PRODUCTS



AIR COMPRESSORS
From DIY to industrial, Plus air tools, spray guns and accessories.

GENERATORS
Prime duty or emergency standby for business, home and leisure.

POWER WASHERS
Hot and cold, electric and engine driven - we have what you need

WELDERS
Mig, Arc, Tig and Spot. From DIY to auto/industrial.

METALWORKING
Drills, grinders and saws for DIY and professional use.

WOODWORKING
Saws, sanders, lathes, mortisers and dust extraction.

HYDRAULICS
Cranes, body repair kits, transmission jacks for all types of workshop use.

WATER PUMPS
Submersible, electric and engine driven for DIY, agriculture and industry.

POWERTOOLS
Angle grinders, cordless drill sets, saws and sanders.

STARTERS/CHARGERS
All sizes for car and commercial use.



PARTS & SERVICE: 0208 988 7400

Parts Enquiries
Parts@clarkeinternational.com

Servicing & Technical Enquiries
Service@clarkeinternational.com

SALES: UK 01992 565333 or Export 00 44 (0)1992 565335

Clarke® INTERNATIONAL Hemnall Street, Epping, Essex CM16 4LG
www.clarkeinternational.com